

Dimensions: inch

MODEL	HP	SIZE		PUMP & MOTOR														Weight Lbs	
		Suc.	Disch.	A	B	C	D <sub>1</sub>	E	F	G	H	H <sub>1</sub>	H <sub>2</sub>	J	K	L	R	1 phase/3 phase	
DWO1506	1.5	2" NPT	2" NPT	7 <sup>5</sup> / <sub>8</sub>	14 <sup>3</sup> / <sub>8</sub>	7 <sup>7</sup> / <sub>8</sub>	7 <sup>1</sup> / <sub>8</sub>	5 <sup>1</sup> / <sub>2</sub>	4 <sup>1</sup> / <sub>4</sub>	2	10	4 <sup>3</sup> / <sub>4</sub>	5 <sup>1</sup> / <sub>4</sub>	5 <sup>5</sup> / <sub>8</sub>	3 <sup>3</sup> / <sub>8</sub>	3 <sup>3</sup> / <sub>8</sub>	2 <sup>7</sup> / <sub>8</sub>	36/34	
DWO2006	2	2" NPT	2" NPT	7 <sup>5</sup> / <sub>8</sub>	14 <sup>3</sup> / <sub>8</sub>	7 <sup>7</sup> / <sub>8</sub>	7 <sup>1</sup> / <sub>8</sub>	5 <sup>1</sup> / <sub>2</sub>	4 <sup>1</sup> / <sub>4</sub>	2	10	4 <sup>3</sup> / <sub>4</sub>	5 <sup>1</sup> / <sub>4</sub>	5 <sup>5</sup> / <sub>8</sub>	3 <sup>3</sup> / <sub>8</sub>	3 <sup>3</sup> / <sub>8</sub>	2 <sup>7</sup> / <sub>8</sub>	42/38	
DWO3006	3	2.5" NPT	2" NPT	7 <sup>5</sup> / <sub>8</sub>	15 <sup>3</sup> / <sub>8</sub>	8 <sup>1</sup> / <sub>2</sub>	7 <sup>1</sup> / <sub>8</sub>	5 <sup>1</sup> / <sub>2</sub>	4 <sup>1</sup> / <sub>4</sub>	2	10	4 <sup>3</sup> / <sub>4</sub>	5 <sup>1</sup> / <sub>4</sub>	5 <sup>5</sup> / <sub>8</sub>	3 <sup>3</sup> / <sub>8</sub>	3 <sup>3</sup> / <sub>8</sub>	3 <sup>3</sup> / <sub>8</sub>	/45	
DWO4006	4	2.5" NPT	2" NPT	7 <sup>5</sup> / <sub>8</sub>	16 <sup>3</sup> / <sub>8</sub>	9 <sup>1</sup> / <sub>2</sub>	7 <sup>1</sup> / <sub>8</sub>	5 <sup>1</sup> / <sub>2</sub>	4 <sup>1</sup> / <sub>4</sub>	2	10	4 <sup>3</sup> / <sub>4</sub>	5 <sup>1</sup> / <sub>4</sub>	5 <sup>5</sup> / <sub>8</sub>	3 <sup>3</sup> / <sub>8</sub>	3 <sup>3</sup> / <sub>8</sub>	3 <sup>3</sup> / <sub>8</sub>	/53	

Dimensions: mm

MODEL	HP	SIZE		PUMP & MOTOR														Weight kg	
		Suc.	Disch.	A	B	C	D <sub>1</sub>	E	F	G	H	H <sub>1</sub>	H <sub>2</sub>	J	K	L	R	1 phase/3 phase	
DWO1506	1.5	2" NPT	2" NPT	193	364	198.5	180	140	107	50	253	120	133	15	9	9	74	13.6/12.6	
DWO2006	2	2" NPT	2" NPT	193	364	198.5	180	140	107	50	253	120	133	15	9	9	74	15.7/14.4	
DWO3006	3	2.5" NPT	2" NPT	193	390	215.5	180	140	107	50	253	120	133	15	9	9	78	/16.9	
DWO4006	4	2.5" NPT	2" NPT	193	415	240.5	180	140	107	50	253	120	133	15	9	9	78	/20	

**Exploded view**

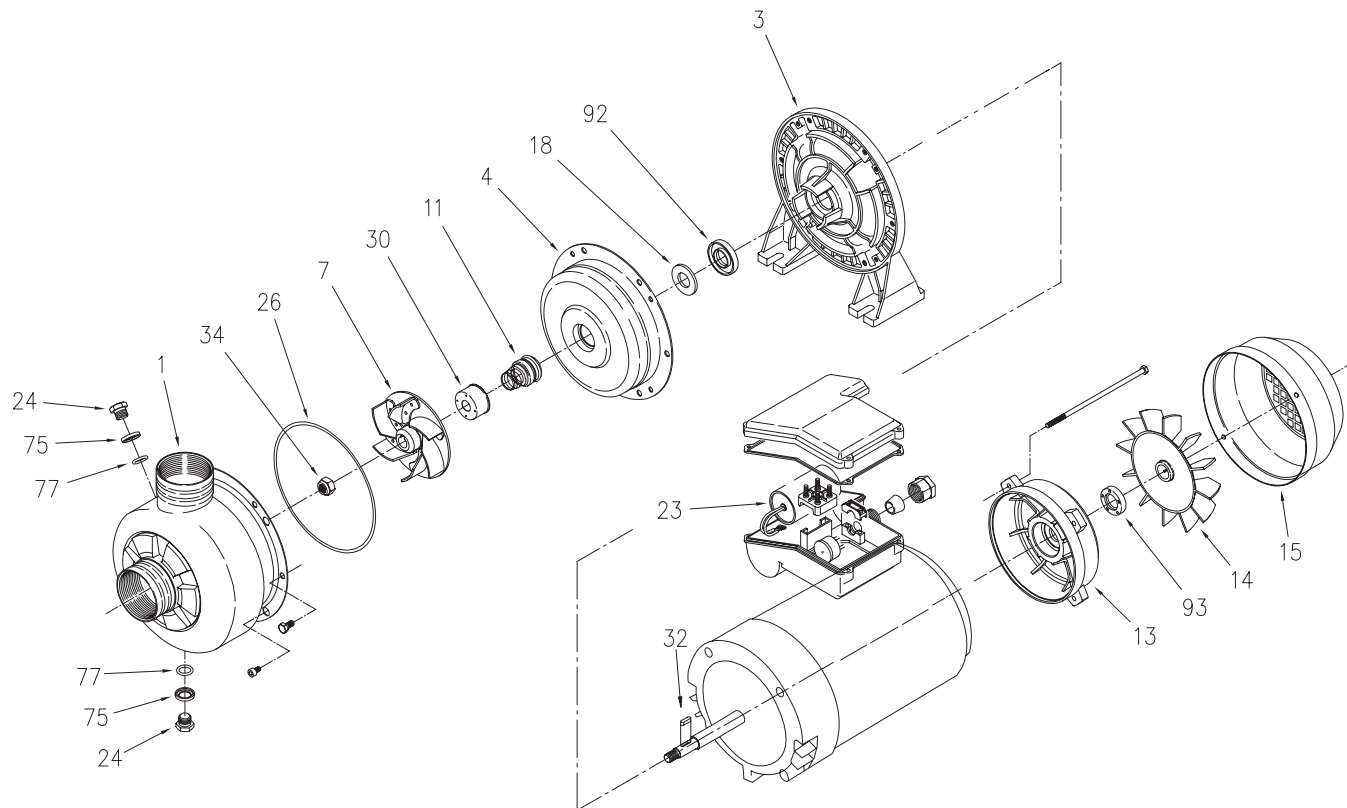

Location No.	Part Name	Material	No. for 1 Unit
1	Casing	304 Stainless Steel	1
3	Motor bracket	Aluminum	1
4	Casing cover	304 Stainless Steel	1
7	Impeller	304 Stainless Steel	1
11	Mechanical seal	Carbon/Ceramic/NBR	1
14	Fan	Polypropolene	1
15	Fan cover	Steel	1
18	Casing Ring	—	1
23	Capacitor	Single phase only	1
24	Priming plug/Drain plug	303 Stainless Steel	2
26	O-ring	NBR	2
30	Splash ring	304 Stainless Steel	1
32	Key	304 Stainless Steel	1
34	Impeller nut	304 Stainless Steel	1
75	Washer	304 Stainless Steel	2
77	O-ring	NBR	2
92	Lip seal (Pump side)	—	1
93	Lip seal (Fan side)	—	1